

Sixteen Channel Digital Video Recorder

Models: DGR116

Installation / User Manual



Under the copyright laws, this documentation may not be copied, photocopied, reproduced, translated, or reduced to any electronic medium or machine-readable form, in whole or part without the prior written consent of Digimerge Technologies Inc., except in the manner described in the documentation.

© Copyright 2003

Digimerge Technologies Inc.
300 Alden Road
Markham, Ontario
L3R 4C1 CANADA

All rights reserved. Printed in Taiwan.

THIS DEVICE COMPLIES WITH PART 15 OF THE FCC RULES.
OPERATION IS SUBJECT TO THE FOLLOWING TWO CONDITIONS:
1. THIS DEVICE MAY NOT CAUSE HARMFULL INTERFERENCE, AND
2. THIS DEVICE MUST ACCEPT ANY INTERFERENCE RECEIVED,
INCLUDING INTERFERENCE THAT MAY CAUSE UNDESIRE
OPERATION.

NOTE: This equipment has been tested and found to comply with the limits for a Class B digital device, pursuant to part 15 of the FCC Rules. These limits are designed to provide reasonable protection against harmful interference when the equipment is operated in a commercial environment. This equipment generates, uses, and can radiate radio frequency energy and, if not installed and used in accordance with the instruction manual, may cause harmful interference to radio communications. However, there is no guarantee that interference will not occur in a particular installation.

Operation of this equipment in a residential area is likely to cause harmful interference in which case the user will be required to correct the interference at one's own expense.

CAUTION: CHANGES OR MODIFICATIONS NOT EXPRESSLY APPROVED BY THE PARTY RESPONSIBLE FOR COMPLIANCE COULD VOID THE USER'S AUTHORITY TO OPERATE THE EQUIPMENT.

Table of Contents

Important Safety Instructions	4
Introduction	5
Features	5
System Contents	6
Getting Started	6
Front Panel Controls	7
Back Panel	9
Accessing the Main Menu	10
Main Menu	10
System	11
Setting the Audio Input Channel	11
Setting the Internal Audible Alarm Buzzer	11
Setting the External Audible Alarm device	11
Setting the Alarm Duration	11
Setting the Dwell Time	12
Setting the Message Latch	12
System Time/Date Set up	12
Selecting the Date Display Format	12
Setting System Time & Date	12
Changing the System Password	13
Clearing the Hard Drive Data	13
Resetting System to Factory Defaults	13
Remote Protocol Setup	13
Search	14
Last Record	14
Full List	14
Alarm List	15
Time Search	15
Timer Recording Setup	15
Timer	15
Record Settings	17
HDD Overwrite Setup:	17
Record IPS Setup:	17
Record Quality Setup	17
Alarm REC IPS setup	17
Alarm REC Quality setup	17
Camera Channel Setup	18
Motion Detection	20
Event Log Viewing	22
Operation	23
Recording	23
Camera Select (1 - 16):	23
View Select:	23
Picture in Picture (PIP):	23
Zoom:	23
Play:	23
Fast Forward (F.F.) & Fast Rewind (F.R.)	24
Slow Forward (S.F.) & Slow Rewind (S.R.)	24

Pausing Playback	24
Image jog dial	24
Video Loss	24
Key Lock.....	24
Troubleshooting	25
Technical Specifications	26
Appendix 1: Installing the HDD	27
Appendix 2: Connection Diagram to Cameras and Monitor	29
Appendix 3: Pin Configurations	30
Pin References for RS-232 / Alarm Block	31
Appendix 4: Rack Mount Installation	33
Appendix 5: Recording Times (in Hours).....	34
Appendix 6: RS232 Remote Protocol.....	35
Appendix 7: Compatible HDD Brands	36
Limited Warranty	37

Important Safety Instructions

All the safety and operating instructions should be read before operating this equipment. The improper operation may cause irreparable damage to the appliance.

Lift and place this equipment gently.

Do not expose this equipment to direct sunlight.

Do not use this equipment near water or in contact with water.

Do not spill liquid of any kind on the equipment.

Do not unplug the power connector before turning the power off correctly.

This equipment should be operated using only the power source from standard package.

Unauthorized repair or parts substitutions may result in fire, electric shock or other hazards.

Do not switch the Power On & Off within short period (within 3 seconds).

Do not attempt to service this equipment by yourself. Refer all servicing to qualified service personnel.

This installation should conform to all local codes.

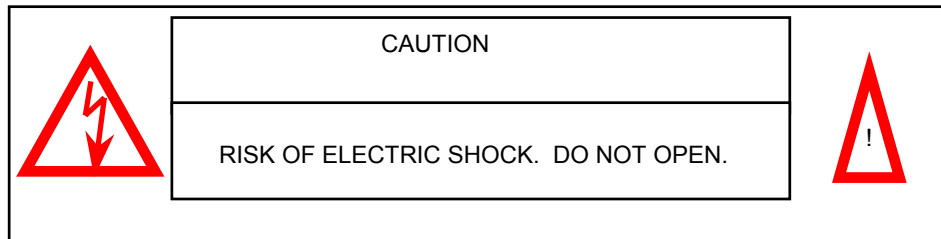

CAUTION: TO REDUCE THE RISK OF ELECTRIC SHOCK, DO NOT REMOVE COVER (OR BACK). NO USER-SERVICEABLE PARTS INSIDE. REFER SERVICING TO QUALIFIED SERVICE PERSONNEL.

Introduction

The DGR116 combines a 16 channel multiplexer with a Digital Video Recorder (DVR).

The DVR offers many advantages over traditional time lapse VCR's, allowing you to quickly access and search for a specific time segment or event which has been recorded. This high quality recorded video can be viewed at various playback speeds as well as frame-by-frame with the Jog Button feature

To learn more about Digimerge products, please visit our website at www.digimerge.com.

Features

- Wavelet Compression Format
- 4 Audio inputs and 2 outputs
- Resolution: 704X564 - full screen, 352X282 - 4 channels, 224X188 9 - channels and 176X141- 16 channels
- Independent main and call monitor outputs allow simultaneous or full screen viewing
- Multi screen display mode
- 16 channel alarm input, alarm display and 1 alarm output
- Video loss detection able to record 160 events on each channel
- Power-loss memory feature (In case of power failure, set-up parameter will remain)
- Supports 2 removable HDD, IDE type (up to a maximum of 240GB)
- Display refresh rate up to 72 IPS (NTSC) and 50 IPS(PAL)
- Record refresh rate up to 15 IPS (NTSC) and 12 IPS (PAL)
- Quick multiple search by date/time, alarm or full list
- Multiple speed playback
- Security password protection
- RS-232, RS-485 communication protocol

System Contents

The DGR116 box should include the items listed below. Please take a moment to verify that no items are missing from the package.



DGR116 Digital Video Recorder



Hard Disk Drives
(not included in all models)



Installation / User Manual



2 Keys for
Hard Drive Cartridge



Power Adapter and Cord

NOTE: KEEP THE KEYS IN A SAFE PLACE. THEY ARE NECESSARY FOR INSTALLATION / REMOVAL OF THE HARD DISK DRIVE.

Getting Started

If the purchased DVR model did not contain a hard disk drive, please refer to Appendix #1 for HDD installation instructions.

1. Connect video sources and monitor(s) following the configuration example shown in [Appendix # 2](#).
2. Connect the AC Power Cord to the Power Adapter and plug into an electrical outlet. A Red LED indicator light will be ON to indicate that the DVR is in Standby mode.
3. Press the Power button. The POWER LED will turn from red to orange, and other red LED indicators will turn ON. Note: the system takes approximately 5 to 15 seconds to power up. During the power-up, you will see the following messages: "HDD Detecting", followed by "Master HDD Connected".

Once connected, the POWER LED will change to green, and red indicator lights be ON next to the Alarm and Timer buttons.

NOTE: IF YOU GET THE MESSAGE "HDD NOT FOUND", PLEASE SEE APPENDIX #1 AS THE HDD IS LIKELY NOT INSTALLED CORRECTLY.

Front Panel Controls

(model may not be exactly as shown)

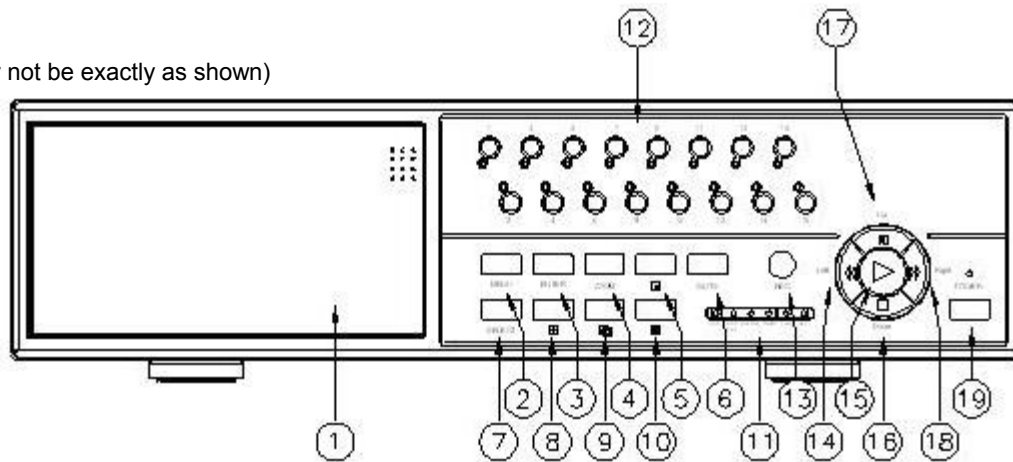

1. Removable Cartridge Casing

The DGR116 comes with 2 removable hard disk drive cartridges.

2. MENU

Press **MENU** to enter the Main Menu. You will be prompted for a password upon pressing the **MENU** button.

3. ENTER

Press **ENTER** for confirmation when making selections in Menu mode.

4. ZOOM

The **ZOOM** feature is used to enlarge a single camera image on the main monitor.

5. PIP

Press  **PIP** button to enter PIP display screen.

6. SLOW

Press **SLOW** to slow down the speed during Play mode. It can also be used to slow down the speed of FAST Forward and Rewind.

7. SELECT

When in a multi-camera viewing mode, this feature is used to select the position of cameras in the multi camera display mode. (for more information, see [view select](#) option in the operation section)

8. Press  to view the 4 channel screen display mode.

9. Press  to toggle between the 7, 9, 10, 13 channel screen display mode.

10. Press  to view the 16 channel screen display mode.

11. Explanation of LEDs

HDD LED: ON when the HDD is active

HDD Full: ON when the HDD is full.

ALARM: ON when the alarm feature is enabled, flashing when an alarm event occurs.

TIMER: ON when Timer feature is "Enabled".

PLAY: ON during Playback

REC: ON during Recording

12. Camera Select (1-16)

Press **Camera Select button** (1-16) to select a camera channel.

13. REC

Press **REC** to start recording. (The  icon will appear in the top-right corner of the screen when recording is in progress.)

14. REW / ◀

The **REW / ◀** button has two functions:

- i. Pressing **REW / ◀** plays video backwards at a high speed. Pressing **REW** adjusts the speed from normal speed to 2X, 4X, 8X, 16X, 32X the normal speed.
- ii. In Menu mode, the **REW / ◀** button is used to scroll Left through options.

15. PLAY

Press **PLAY** to play recorded video. The DGR116 will play the last recorded video by default.

16. STOP / ▼

The **STOP / ▼** button has two functions

- i. Pressing **STOP / ▼** terminates recording or playing. The DGR116 returns to live monitoring mode and stops all other actions.
- ii. In Menu mode, the **STOP / ▼** button is used to scroll down through options.

17. PAUSE / ▲

The **PAUSE / ▲** button has two functions

- i. Pressing **PAUSE / ▲** pauses the recorded video being played on screen.
- ii. In Menu mode, the **PAUSE / ▲** button is used to scroll Up through options.

18. FF / ▶

The **FF / ▶** button has two functions

- i. Pressing **FF / ▶** plays video forwards at a high speed. Pressing **FF** adjusts the speed from normal speed to 2X, 4X, 8X, 16X, 32X the normal speed.
- ii. In Menu mode, the **FF / ▶** button is used to scroll Right through options.

19. POWER

Press **POWER** to turn the DGR116 system ON and OFF.

Back Panel

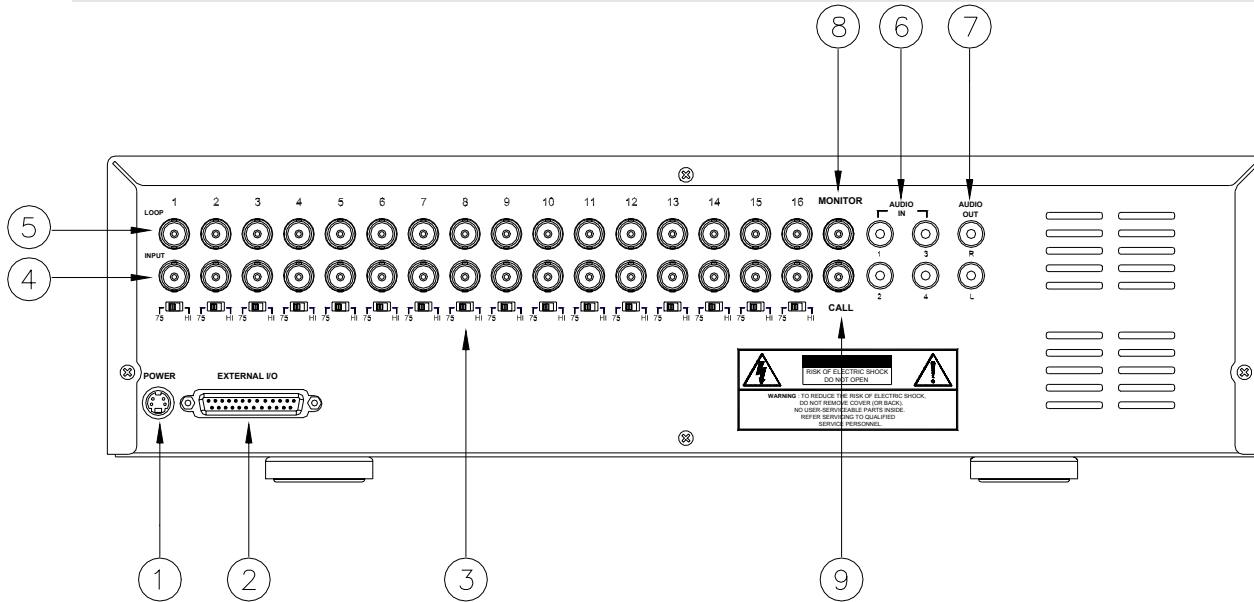

1. **POWER INPUT**
Connects to the Power cord.
2. **EXTERNAL I/O**
Connects to a PC for Remote Control via RS-232 or to an Alarm Block. (see appendix 6 for more info)
3. **75/OH**
When using the LOOP function, allows for HI impedance or 75ohms.
4. **VIDEO INPUT (1-16)**
Connects to a video source i.e (camera).
5. **LOOP**
Allows connection to other video devices
6. **AUDIO INPUTS (1-4)**
Connects to an audio source for recording purposes (i.e. microphone)
7. **AUDIO OUTPUTS (R/L)**
Connects to a speaker (or a monitor with audio speaker)
8. **MONITOR**
Connects to main monitor
9. **CALL**
Connects to the CALL monitor for real time sequencing.

Accessing the Main Menu

The Menu allows you to configure your DVR settings and program various recording options. Follow these steps in order to access the Menu:

Press the **MENU** button. The password screen will appear:



Password: 0000

The default Password is 0000.

To change the number of the Password, use the ◀ / ▶ buttons to scroll left and right between numbers, and use the ▲ / ▼ buttons to change the value of the number that is flashing.

Press the **ENTER** button once the correct Password is entered. The menu options screen will appear.

NOTE: If you get a message “Password Error”, you have entered an incorrect password.

Main Menu

When the correct password is entered, the main menu options will be displayed.

There are 6 options available in the Main Menu:

Search: Finds recorded list
Timer: Scheduling Recording
Record: Record mode set-up
Camera: Camera channel set-up
System: System Setup (Sets the date, chooses an HDD overwrite setting, changes password, resets system settings, or clears the HDD)
Event: Event List - Allows you to view video from a list of recorded events

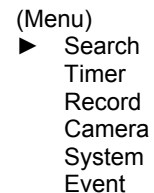

(Menu)
▶ Search
Timer
Record
Camera
System
Event

Navigating the Menu:

▲ / ▼: Scroll up and down through menu options; change values when an option is selected and is blinking
◀ / ▶: Scroll sideways within a menu option that has been selected

ENTER: Selects a submenu / an option in a submenu for browsing / modification
MENU: Completes modification of a menu option; exits a menu

NOTE: The Menu setup will timeout after 1 minute of no key presses.

System

The system menu is used to configure the system level options of the DGR116...

To access the System features, press **MENU** followed by the 4 digit password. Use the ▲ / ▼ to scroll to the “System” option and press **ENTER**.

(SYSTEM)	
Audio Input:	1
Int Audible Alarm:	ON
Ext Audible Alarm:	ON
Alarm Duration:	10 SEC
Dwell Time:	02 SEC
Message Latch:	NO
Title Display:	ON
Time Display:	Y/M/D
2003-JAN-02 (THU) 17:37:09	
New Password:	XXXX
Clear HDD:	NO
System Reset:	NO
Remote Mode:	RS-232
Baud Rate:	9600
Remote ID:	000

Using the ▲ / ▼ buttons, scroll to the desired option and press **ENTER** to select it.

Setting the Audio Input Channel

This Feature is used to select the audio channel to record. To set this Audio Input Channel:

1. On the System screen, press ▲ / ▼ to select Audio Input, then press **ENTER**.
2. Press ▲ / ▼ to select the desired time audio channel (1-4)
3. Press **MENU** to confirm your change.
4. Press ▲ / ▼ to move to another field on the System screen or press **MENU** to exit.

Setting the Internal Audible Alarm Buzzer

To enable or disable the internal audible alarm buzzer:

1. On the System screen, press ▲ / ▼ to select Internal audible alarm Buzzer, then press **ENTER**.
2. Press ▲ / ▼ to enable or disable the internal audible alarm buzzer. Options are:
ON = Buzzer is on. When the DVR detects an alarm, the system sounds the internal buzzer to alert the user.
OFF = Buzzer is off.
3. Press **MENU** to confirm your change.
4. Press ▲ / ▼ to move to another field on the System screen or press **MENU** to exit.

Setting the External Audible Alarm device

To enable or disable the External Audible Alarm Device:

1. On the System screen, press ▲ / ▼ to select External Audible Alarm Device, then press **ENTER**.
2. Press ▲ / ▼ to enable or disable the External Audible Alarm Device. Options are:
ON = External Device is on. When the DVR detects an alarm, the system triggers the external audible alarm.
OFF = External Device is Off
3. Press **MENU** to confirm your change.
4. Press ▲ / ▼ to move to another field on the System screen or press **MENU** to exit.

Setting the Alarm Duration

To set the duration of the Alarm:

1. On the System screen, press ▲ / ▼ to select Alarm Duration, then press **ENTER**.
2. Press ▲ / ▼ to select the desired time (10s, 15s, 20, 30, 1min, 2min, 3min, 5min, 10min, 15min, 30min, always)
3. Press **MENU** to confirm your change.
4. Press ▲ / ▼ to move to another field on the System screen or press **MENU** to exit.

Setting the Dwell Time

This timer is used to select the amount of time (between 1-10s) a channel appears on the monitor before sequencing to the next channel. To Set the Dwell Time:

1. On the System screen, press ▲ / ▼ to select Dwell Time, then press **ENTER**.
2. Press ▲ / ▼ to select the desired time (1-10s)
3. Press **MENU** to confirm your change.
4. Press ▲ / ▼ to move to another field on the System screen or press **MENU** to exit.

Setting the Message Latch

This feature determines if the On Screen messages will remain on the screen or disappear after 10s. To set the Message Latch:

1. On the System screen, press ▲ / ▼ to select Message Latch, then press **ENTER**.
2. Press ▲ / ▼ to enable or disable the Message Latch feature. Options are:
NO = Screen messages will disappear after a 10 sec. (this is the default setting)
YES = On Screen messages will remain on the screen for the duration of the event.
3. Press **MENU** to confirm your change.
4. Press ▲ / ▼ to move to another field on the System screen or press **MENU** to exit.

System Time/Date Set up

Selecting the Date Display Format

1. On the System screen, press ▲ / ▼ to select Date Display, then press **ENTER**.
2. Press ▲ / ▼ to choose a display format. Options are:
Y-M-D = Year - Month - Day
M-D-Y = Month - Day - Year
D-M-Y = Day - Month - Year
Off = The date and time will not show on the screen.
3. Press **MENU** to confirm your change.
4. Press ▲ / ▼ to move to another field on the System screen or press **MENU** to exit this screen and confirm the current operation.

Setting System Time & Date

1. On the System screen, press ▲ / ▼ to select System Time & Date, then press **ENTER**.
2. Press ▲ / ▼ to choose a number, then press ◀ / ▶ to move to the next digit:
2003-Jan-01 (Mon) 22:38:29
3. Press **MENU** to confirm your change.
4. Press ▲ / ▼ to move to another field on the System screen or press **MENU** to exit this screen and confirm the current operation.

Changing the System Password

1. On the System screen, press ▲ / ▼ to select New Password, then press **ENTER**.
2. Press ▲ / ▼ to choose a number, then press ◀ / ▶ to move to the next digit:
3. Press **MENU** to confirm your change.
4. Press ▲ / ▼ move to another field on the System screen or press **MENU** to exit this screen and confirm the current operation.
5. If you have completed all your system configuration changes, press **MENU** again to exit and close menu setup.

Clearing the Hard Drive Data

This option will erase all data from the hard drive.

Ensure that there are no important recordings on the disk before using this option.

1. On the System screen, press ▲ / ▼ to select Clear HDD, then press **ENTER**.
2. Press ▲ / ▼ to choose YES to clear the HDD or NO to leave as is.
3. When you choose “Yes” on this option and press **ENTER**, the DVR will prompt:
4. Press ▶ to confirm clearing, or ◀ to cancel.
5. Press **MENU** to confirm your change.
6. Press ▲ / ▼ to move to another field on the System screen or press **MENU** to exit this screen and confirm the current operation.

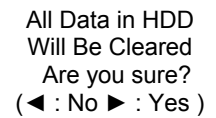

All Data in HDD
Will Be Cleared
Are you sure?
(◀ : No ▶ : Yes)

NOTE: Clearing the data from the Hard Drive results in permanent, irreversible loss of all video and related data currently stored on the Hard Drive.

Resetting System to Factory Defaults

Using the System Reset option will set all options back to factory default settings. Use the steps below to perform this option.

1. On the System screen, press ▲ / ▼ to select **System Reset**, then press **ENTER**.
2. Press ▲ / ▼ to choose:
Yes = Confirm the system reset and load the default settings.
No = Do not reset the system at this time.
3. Press **MENU** to exit this screen and confirm the current operation.
4. If you have completed all your system configuration changes, press **MENU** again to exit and close menu setup.

NOTE: This will not affect the time and date settings.

Remote Protocol Setup

This feature is used to set the basic RS-232/RS-485 protocols to control the DVR remotely from a PC.

Pressing **ENTER** after scrolling to the Remote option will bring up the following menu options:

Remote mode: Selects whether to use an RS-232 or RS-485 interface.

Baud rate: Selects the baud rate (bps) to be used for the connection.
The available settings are: 115200, 57600, 19200, 9600, 3600, 2400, 1200.

ID: Selects a numerical number representing the remote protocol id if required.
The available setting are: 000 – 999

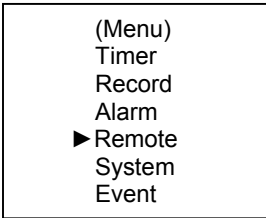

(Menu)
Timer
Record
Alarm
▶ Remote
System
Event

The remote connection on the DVR uses 8 data bits, 1 start bit, and 1 stop bit.

Below is an example of the data stream with the control codes shown.

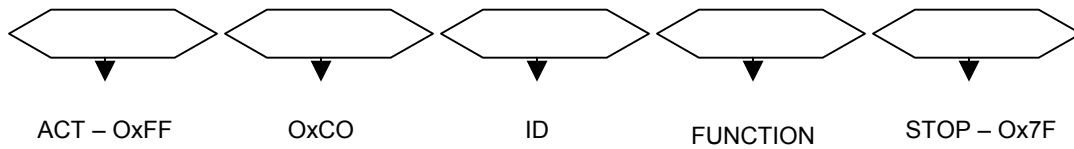

Please refer to [Appendix 3](#) for information on the Pin connections and command protocols that would be used in this application.

Search

The DGR116 allows you to easily find sections of recorded video using the **SEARCH** feature.

To access the Search option, press **MENU** followed by the 4 digit password. Use the **▲ / ▼** to scroll to the **Search** option and press **ENTER**.

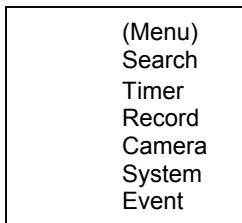

The following options are available in the Search Menu...

Last Record

This feature is used to play the last recorded piece of video.

- In the Search menu, press **▲ / ▼** to scroll to the Last Record option, then press **ENTER**.
- The last recorded video will begin playing

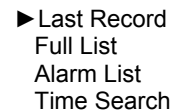

Full List

This Feature is used to choose from a listing of all recorded video on the HDD sorted by time.

1. In the Search menu, press **▲ / ▼** to scroll to the Full List option, then press **ENTER**.
2. Press **▲ / ▼** to select the desired recorded video and press **◀ / ▶** to change pages.
3. Press **ENTER** to play selected video.

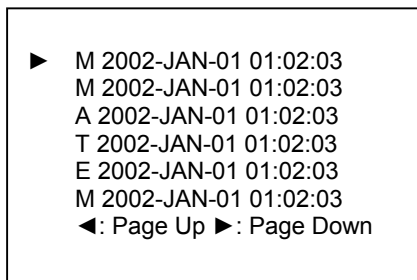

An example of a Full List search is shown on the left.

Note that the date and time appear, along with the letter representing the method of recording that took place.

Press **ENTER** to view a selected piece of video on the list. The DGR116 will play the video in chronological order, until it hits the End of the list. Playback can be stopped at any time by pressing the **STOP** button.

M: Manual Record Time
A: Alarm Record Time
M-HDD: Storage in Master HDD
S-HDD: Storage in Slave HDD

Alarm List

This feature shows a listing of all recorded video triggered by an Alarm.

1. In the Search menu, press ▲ / ▼ to scroll to the Alarm List option, then press **ENTER**.
2. Press ▲ / ▼ to select the desired recorded video and press ◀ / ▶ to change pages.
3. Press **ENTER** to play selected video.

Time Search

This feature finds video recorded on a specific time and date that is entered.

1. In the Search menu, press ▲ / ▼ to scroll to the Time Search option, then press **ENTER**.
2. Press ▲ / ▼ to select the desired time and date, and press ◀ / ▶ to move to the next character.
3. Press **ENTER** to play selected video.

NOTE: If there is no record found that matches the selected time and date, the screen will display “**NOT FOUND**”.

Timer Recording Setup

On the Main menu, selecting the Timer option will allow you to set daily schedules in which you would like the DVR to automatically record.

Pressing **ENTER** after scrolling to the Timer option will bring up the following menu options:

(Menu)
Search
▶ Timer
Record
Camera
System
Event

Timer

(Timer)			
Day	Start	End	IPS
Daily	01:00	02:00	Off
SUN	12:00	13:00	Off
MON	08:00	09:00	Off
MO~FR	00:00	01:00	Off
SA~SU	20:00	21:00	Off
JAN-01	15:00	16:00	Off
Timer Enable:	No		

1. Press ▲ / ▼ to select the day(s) to record on, the available options are...

Daily: Everyday
SUN: Sunday
MON: Monday
TUE: Tuesday
WED: Wednesday
THU: Thursday
FRI: Friday
SAT: Saturday
MO-FR: Monday to Friday
SA-SU: Saturday & Sunday
JAN-01: Special Date
OFF: Not activated

2. Use the ◀ / ▶ scroll keys to move to START record time 00:00 (HH:MM)
Press ▲ / ▼ to set the start time
3. Press ◀ / ▶ move to END record time 00:00 (HH:MM)
Press ▲ / ▼ to change END record Time numerical digit
4. Press ◀ / ▶ move to QUALITY
Press ▲ / ▼ to choose options of
BEST, HIGH, NORMAL, BASIC
5. Press ◀ / ▶ move to Record IPS (Images Per Second)
Press ▲ / ▼ to choose one of the following options
NTSC: 15A, 15, 8, 4, 2, 1
PAL: 12A, 12, 6, 3, 2, 1

6. Press **MENU** to confirm current operation, and enter to next Timer Record setup.
7. Press ◀ / ▶ move location to Timer Enable Yes or No setup
YES : To confirm Timer Enable Scheduling Timer Record feature
NO : To confirm no Timer Enable No Scheduling Timer Record feature
8. Press **MENU** to exit and confirm current operation.
9. Press **MENU** again to exit and close TIMER setup mode.

NOTE: WHEN THE TIMER IS SET, THE REC LED INDICATOR WILL BE ON. ALTHOUGH THE LIGHT MAY BE ON, THE SYSTEM IS NOT NECESSARILY RECORDING SINCE IT WILL ONLY RECORD DURING ITS SCHEDULED TIME.

Record Settings

On the Main menu, selecting the Record option will allow you to set the quality and speed of recordings.

Pressing **ENTER** after scrolling to the Record option will bring up the following menu options:

(RECORD)
HDD Overwrite: NO
Record IPS: 15A
Record Quality: Normal
Alarm Rec IPS: 15A
Alarm Rec Quality: Normal

(Menu)
Search
Timer
▶ Record
Alarm
Remote
System
Event

HDD Overwrite Setup:

1. Press **ENTER** to confirm HDD OVERWRITE setup.
2. Press **▲ / ▼** to choose HDD OVERWRITE.
NO: When HDD full will stop recording
YES: When HDD full will overwrite the HDD recording
3. Press **MENU** to exit and confirm current operation.
4. Press **MENU** again to exit and close HDD OVERWRITE setup mode.

Record IPS Setup:

1. Press **ENTER** to confirm RECORD IPS setup.
2. Press **▲ / ▼** to choose IPS record speed.
NTSC: 15A, 15, 8, 4, 2, 1
PAL: 12A, 12, 6, 3, 2, 1
3. Press **MENU** to exit and confirm current operation.
4. Press **MENU** again to exit and close RECORD IPS setup mode.

Record Quality Setup

1. Press **ENTER** to confirm Record Quality setup.
2. Press **▲ / ▼** to choose Record Quality level.
BEST, HIGH, NORMAL, BASIC
3. Press **MENU** to exit and confirm current operation.
4. Press **MENU** again to exit and close RECORD QUALITY setup mode.

Alarm REC IPS setup



1. Press **ENTER** to confirm ALARM REC IPS setup.
2. Press **▲ / ▼** to choose ALARM REC IPS record speed.
NTSC: 15A, 15, 8, 4, 2, 1
PAL: 12A, 12, 6, 3, 2, 1
3. Press **MENU** to exit and confirm current operation.
4. Press **MENU** again to exit and close ALARM REC IPS setup mode.

Alarm REC Quality setup

1. Press **ENTER** to confirm ALARM REC QUALITY setup.
2. Press **▲ / ▼** to choose ALARM REC QUALITY level.
BEST, HIGH, NORMAL, BASIC
3. Press **MENU** to exit and confirm current operation.
4. Press **MENU** again to exit and close ALARM REC QUALITY setup mode.

Camera Channel Setup

To access the Camera option, press **MENU** followed by the 4 digit password. Use the ▲ / ▼ to scroll to the Camera option and press **ENTER**.

TITLE	DWELL				ALARM	RECORD
---01	ON	5	5	5	LOW	EVENT
---02	ON	5	5	5	LOW	EVENT
---03	ON	5	5	5	LOW	EVENT
---04	ON	5	5	5	LOW	EVENT
---05	ON	5	5	5	LOW	EVENT
---06	ON	5	5	5	LOW	EVENT
---07	ON	5	5	5	LOW	EVENT
---08	ON	5	5	5	LOW	EVENT
---09	ON	5	5	5	LOW	EVENT
---10	ON	5	5	5	LOW	EVENT
---11	ON	5	5	5	LOW	EVENT
---12	ON	5	5	5	LOW	EVENT
---13	ON	5	5	5	LOW	EVENT
---14	ON	5	5	5	LOW	EVENT
---15	ON	5	5	5	LOW	EVENT
---16	ON	5	5	5	LOW	EVENT

The options available in this section are as follows...

Title

This feature is used to assign a 6 character title to each camera input.

1. Press ▲ / ▼ to select the desired time camera channel (1-16), then press **ENTER**.
2. Press ▲ / ▼ to select the desired character and ◀ / ▶ to move to the next character
3. Press **MENU** to confirm and exit the **Title** setting.
4. Press **MENU** again to exit the Camera Setup Option

Dwell

This feature is used to enable or disable the dwell feature for each camera when viewing using the call monitor output.

1. Press ▲ / ▼ to select the desired time camera channel (1-16), then press **ENTER**.
2. Press ◀ / ▶ to select the **Dwell** feature on the screen.
3. Press **MENU** to confirm and exit the dwell setting.
4. Press **MENU** again to exit the Camera Setup Option

Brightness / Contrast / Color

This feature is used to adjust the video settings on each channel.

1. Press ▲ / ▼ to select the desired time camera channel (1-16), then press **ENTER**.
2. Press ◀ / ▶ to select the **Brightness, Contrast, or Color** feature on the screen.
3. Press ▲ / ▼ to select **0~9** on the screen.
4. Press **MENU** to confirm and exit the **Brightness, Contrast, or Color** control feature
5. Press **MENU** again to exit the Camera Setup Option

Alarm Polarity

This feature is used to select the alarm polarity as LOW / OFF / HIGH.

1. Press ▲ / ▼ to select the desired time camera channel (1-16), then press **ENTER**.
2. Press ◀ / ▶ to select the **Alarm Polarity** feature on the screen.
3. Press ▲ / ▼ to select **LOW / OFF / HIGH** on the screen.
4. Press **MENU** to confirm and exit the **Alarm Polarity** feature
5. Press **MENU** again to exit the Camera Setup Option

Record Method

This feature is used to select the DVR record method as either EVENT / NORMAL / OFF.

1. Press ▲ / ▼ to select the desired time camera channel (1-16), then press **ENTER**.
2. Press ◀ / ▶ to select the **Record Method** feature on the screen.
3. Press ▲ / ▼ to select **EVENT/ NORMAL/ OFF** on the screen.

EVENT: when the alarm input is triggered, the DVR will increase the recording time to that channel.
i.e. the normal record sequence for cameras is camera 1, camera 2, camera 3 etc... In Event mode, when an alarm is triggered from channel 1, the DVR will record using the following sequence....., Camera 1, Camera 2, Camera 1, Camera 3, Camera 1, Camera 4 etc....

NORMAL: When an External Audible Alarm is triggered, the DVR will record normally as set up.

OFF: An Alarm Trigger will not cause the DVR to start recording

4. Press **MENU** to confirm and exit the **Record Method** feature
5. Press **MENU** again to exit the Camera Setup Option

Motion Detection

Press **MENU** to enter the menu set up, then **▼** to **CAMERA** setup.
 Press **ENTER** twice to enter the Motion Detection Setup.

Each screen displays the current camera picture overlaid with the motion targets (as [Figure 1](#)). Pressing the **◀ / ▶**, **▲ / ▼** buttons will toggle the motion detection between **ON** or **OFF**.

The targets on each motion setup can be turned to ON or OFF individually by row. To set up targets, using the following front panel buttons:

1. Press **ENTER** to confirm the channel
2. Press **ENTER** to enter motion mode
3. **▲** moves the target cursor up one row at a time.
4. **▼** moves the target cursor down one row at a time.
5. **◀** moves the target cursor left one column at a time.
6. **▶** moves the target cursor right one column at a time.
7. Press **ENTER** to turn the target cursor ON
 Press **ENTER** again to turn the target cursor OFF
8. **Camera Select (1-15)** toggles the corresponding target on the cursor line ON or OFF. (see [Figure 1.1](#)) There are only 15 targets in a row, therefore; only Camera Selected (1-15) can be operated.
9. **Zoom**: turns all targets in the current row ON or OFF. ([Figure 1-2](#))
10. **PIP**: turns all targets on the screen ON or OFF. ([Figure 1-3](#))

Press **SLOW** button to setup the Sensitivity list up to 255

1. Press **REC** button to setup the Sensitivity list down to 000
2. Sensitivity value is related to motion and brightness change.
3. Low value (as 001) means higher sensitivity on motion and brightness change.
4. High value (as 255) means lower sensitivity on motion and brightness change.
 User can choose the suitable sensitivity value in different locations. The default value is set on 32.

Figure 1 **MOTION DETECTION SETUP**

1	2	3	4	5	6	7	8	9	10	11	12	13	14	15
☒	☒	☒	☒	☒	☒	☒	☒	☒	☒	☒	☒	☒	☒	☒
☒	☒	☒	☒	☒	☒	☒	☒	☒	☒	☒	☒	☒	☒	☒
☒	☒	☒	☒	☒	☒	☒	032	☒	☒	☒	☒	☒	☒	☒
☒	☒	☒	☒	☒	☒	☒	☒	☒	☒	☒	☒	☒	☒	☒
☒	--	☒	--	☒	--	☒	--	☒	--	☒	--	☒	--	☒
☒	☒	☒	☒	☒	☒	☒	☒	☒	☒	☒	☒	☒	☒	☒
☒	☒	☒	☒	☒	☒	☒	☒	☒	☒	☒	☒	☒	☒	☒
☒	☒	☒	☒	☒	☒	☒	☒	☒	☒	☒	☒	☒	☒	☒
☒	☒	☒	☒	☒	☒	☒	☒	☒	☒	☒	☒	☒	☒	☒
☒	☒	☒	☒	☒	☒	☒	☒	☒	☒	☒	☒	☒	☒	☒

Figure 1-1 MOTION DETECTION SETUP – 1~16

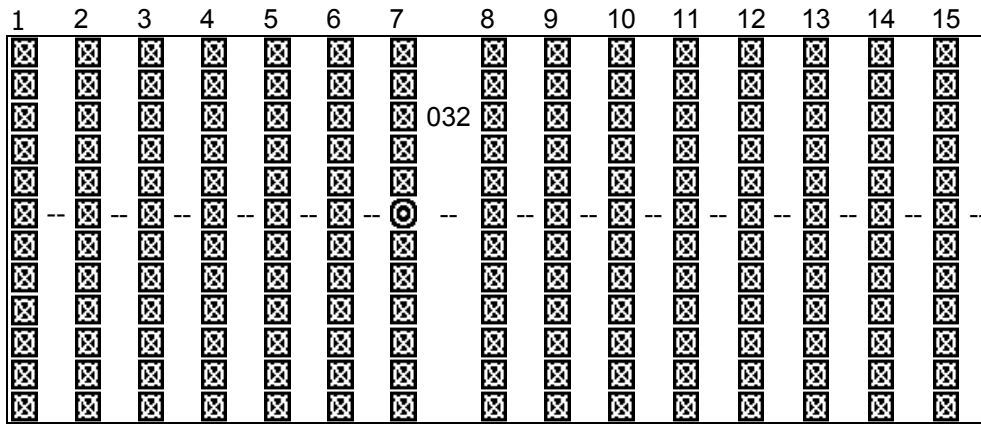

Figure 1-2 MOTION DETECTION SETUP – LINE

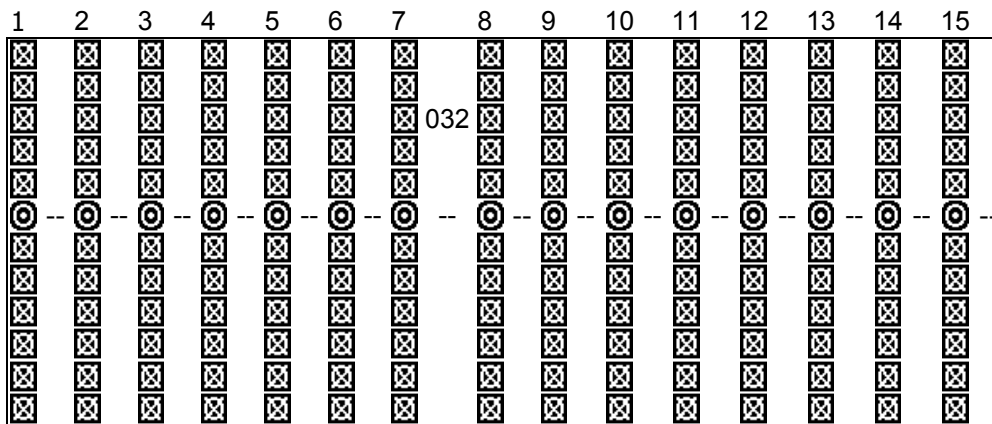
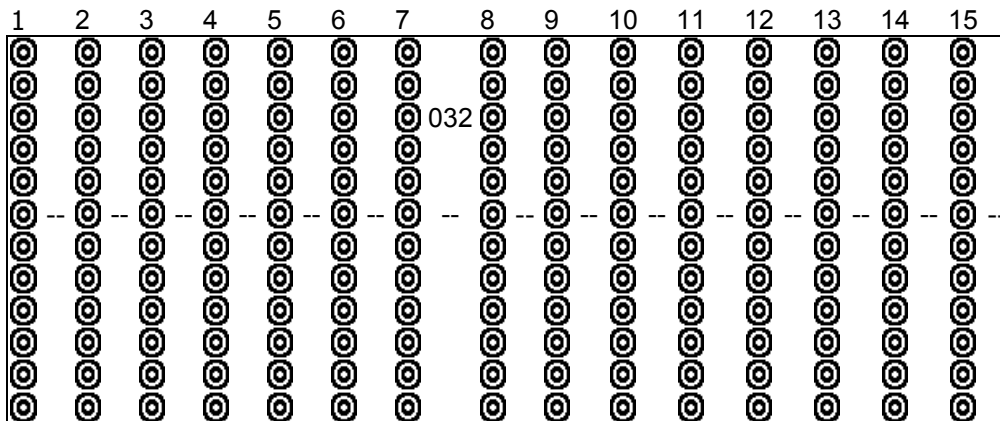

Figure 1-3 MOTION DETECTION SETUP – ALL



Event Log Viewing

To access the Event Log Viewing option, press **MENU** followed by the 4 digit password. Use the ▲ / ▼ to scroll to the **Event** option and press **ENTER** to view the list of logged events.

Use the ▲ / ▼ to scroll through the events on the display and ◀ / ▶ to go to the next page. To view the video associated with an event, scroll to the event and press **ENTER**.

The following is a list of events that can be displayed on the DGR116.

- M-HDD WARNING:** Master HDD might be failed
- M-HDD LOSS:** Master HDD does not exist. User can use other HDD.
- M-HDD ERROR:** Master HDD may contain error.
- S-HDD WARNING:** Slave HDD may have failed.
- S-HDD LOSS:** Slave HDD does not exist. User can use other HDD
- S-HDD ERROR:** Slave HDD may contain error.
- HDD FULL:** HDD is full.
- SYSTEM ERROR:** System may have failed.
- 02 VLOSS:** Channel: 2 Video Loss
- 03 ALARM:** Channel: 3 External I/O Alarm triggered.
- POWER RESTORE:** Power restore.

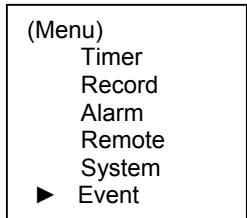

Operation

Recording

The DGR116 offers a variety of flexible recording modes. The unit can be set up to record continually, following a schedule, or by record events. In addition, the recording speed and resolution is also configurable (*these options are configurable through the system menu*). Under the recording status, if power is stopped accidentally, recorded video will still be stored in the HDD and will be available when the power is restored, and the original recording setup will remain.

When recording, the top line of the display will show the date, time, and the amount of available HDD memory (in GB).

In the example below, the letter "A" represents the alarm trigger and the letters "OW" represents HDD over write.

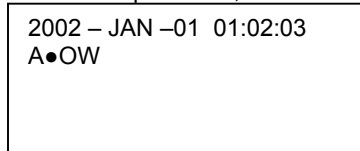

There are 3 record modes for DGR116: Alarm Record, Timer Record, and Manual Record.



- 1. Alarm Record**
The display will indicate a recording triggered by an Alarm using the letter "A".
- 2. Timer Record**
The display will indicate a scheduled recording using the the letter "T".
- 3. Manual Record**
The display will indicate a manual recording (by pressing the REC button) using the letter "M".

Camera Select (1 - 16):

Press Camera Select (1 - 16) button to select the desired camera to display in full screen mode.

View Select:

This button is used to select the ideal viewing configuration.

1. Press the    button to toggle through the screen configurations.
2. Press **SELECT**, then ◀ / ▶ to select a viewing window.
3. Press the **Camera Select (1-16)** to insert the desired camera into the selected window.
4. Press the **MENU** button to save the new configuration and exit.

Picture in Picture (PIP):

This button is used to configure the monitor so a full screen is displayed in the background with a 1/16th size screen insert.

1. Press the  button to display the PIP mode.
2. Press **SELECT** then ◀ / ▶ button to move the insert screen.
3. Press **MENU** to exit

Zoom:

Feature is used to enlarge the display (2X) the size of the main picture. The screen will now display the "zoomed" picture as the main picture with a small window inserted containing a moveable 1/4 view size of the appointed camera.

1. Select the desired camera by pressing Camera Select (1-16).
2. Press the **Zoom** button to zoom the image on the display.
3. Press the **Zoom** button again to move the zoom pointer.
4. Press **MENU** to exit

Play:

This button is used to select the Play mode. It will play the last recorded video.

Fast Forward (F.F.) & Fast Rewind (F.R.)

Press **PLAY** then ►► for fast forward searching.

Press ►► once to view the forward playback in double speed. Continuing to press ►► will increase playback up to a max of 32X.

Press **PLAY** then ◀◀ for fast rewind searching.

Press ◀◀ once to view the reverse playback in double speed. Continuing to press ◀◀ will increase reverse playback up to a max of 32X.

Slow Forward (S.F.) & Slow Rewind (S.R.)

Press **PLAY** then **SLOW** for slow play.

Press ►► once to reduce the playback to 1/2 speed. Continuing to press ►► will slow down the playback to a max of 1/32X normal speed.

Press **PLAY** then press **SLOW** for slow play. Press ◀◀ once to reduce the rewind playback to ½ speed. Continuing to press ◀◀ will slow down the rewind playback to a max of 1/32X normal speed.

Pausing Playback

To pause during playback:

Press **PAUSE**, the display will pause on the active screen.

(If Stop is pressed during playback or during a pause, the DGR116 will jump to the live monitoring mode.)

Image jog dial

To use the image jog feature, press **PLAY** followed by the **PAUSE** button (this will cause the screen to pause).

To **Forward Image Jog**: Press the ►► to activate the single image play, (showing one image for each ►► button press)

To **Rewind Image Jog**: Press the ◀◀ to activate the single image play, (showing one image for each ◀◀ button press)

Video Loss

Screen will display  if the video input is not connected properly.

Key Lock

For added security, you can Lock the buttons on your DGR116. Locking disables the functionality of the buttons and prevents accidental key presses from altering the operation of the DGR116.

To **enable** the Key Lock feature, press and hold the **ENTER** and **MENU** at the same time.

To **disable** the Key Lock feature when it is locked, press and the **ENTER** and **MENU** at the same time.

Troubleshooting

PROBLEM	SOLUTION
HDD not found	Need to insert HDD Make sure that the HDD Cartridge is locked, then press any key to continue
No Power	Check the power source cord connections Check that there is power at the outlet
Buttons aren't working when pressed	Check if the system is in Key Lock mode Press MENU and ENTER at the same time to escape the Key Lock mode
No recorded video	Check that the HDD has been installed correctly
Timer / Alarm recording isn't working	Check that Timer / Alarm Enable is set to YES
No video	Check camera's video cables and connections Check monitor's video cables and connections Make sure that the camera is receiving power

Technical Specifications

Video format	NTSC/EIA or PAL/CCIR
HDD storage	IDE type, UTMA 66 above, 2 removable HDD's supported
Record mode	Manual / Alarm / Timer
Camera input signal	Composite video signal 1 Vp-p 75Ω BNC, 16 Channels
Camera loop back	Composite video signal 1 Vp-p 75Ω BNC, 16 Channels
Main monitor output	Composite video signal 1 Vp-p 75Ω BNC
Call monitor output	Composite video signal 1 Vp-p 75Ω BNC
Audio input/ output	4 audio inputs, (RCA) and 2 audio outputs, (RCA)
Motion detect area	15 X 12 Targets per camera (NTSC)/ 15*14 targets per camera (PAL)
Motion detect sensitivity	256 Levels
Video loss detection	Yes
Refresh rate	72 IPS for NTSC / 100 IPS for PAL
Recording rate	15 IPS for NTSC / 12 IPS for PAL
Dwell time	Programmable (1 - 10 Sec)
Picture in picture	Yes (Moveable)
Key lock	Yes
Picture zoom	2X (Moveable)
Camera title	6 Characters
Video adjustable	Color / Contrast / Brightness Adjustable
Alarm input / output	Input: TTL input, Hi (5V), Low (GND) Output: COM,/N.O/N.C
Remote control	RS-232 or RS-485
Time display format	YY/NN/DD, DD/MM/YY, MM/DD/YY, OFF
Power source	AC 100-240V +/- 10% switching adaptor
Power consumption	<45W
Operation temperature	10 - 40 degrees C
RS - 232c / RS-485	115200, 57600, 19200, 9600, 4800, 3600, 2400, 1200 bps
Dimension (mm)	432 (W) x 110 (H) x 325 (D)
Net weight	5.7 Kgs

Appendix 1: Installing the HDD

NOTE: The HDD has the same purpose in a DGR116 as a video cassette does in a VCR. However, installing the HDD is a bit more complicated. Please follow the next steps carefully in order to ensure proper installation.

The compartment (with the handle) located on the front panel of the DGR116 is the removable Cartridge Casing where the HDD is inserted. The various parts of the Cartridge Casing are labeled for your reference.

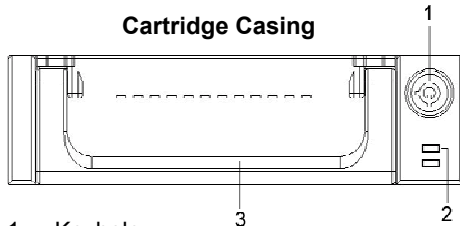

1. Keyhole
2. LED indicator lights (Power indicator & HDD Access indicator)
3. Handle

Step 1: Remove the Cartridge Casing from the DGR116

Lift the Handle and pull towards you. The Cartridge Casing will slide out of the DGR116.

NOTE: The Cartridge must be unlocked to remove it, (please see [step 8](#) for more information on locking and unlocking the removable HDD cartridge).

Step 2: Remove the Cover from the Cartridge Casing

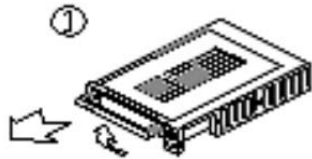

Step 3: Unclip the release latch with the word “OPEN” printed beside it by gently pushing on the latch.

Step 4: Slide the cover off the Cartridge Casing.



Step 5: Insert the HDD into the Cartridge Casing

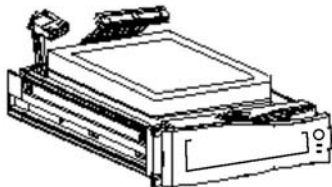

Take the Hard Disk Drive and connect the two cables from the back of the Cartridge Casing to the HDD.

The cables should be pushed in firmly, but not forcibly.

Note: When using more than 1 HDD, configure the jumpers on the HDD so one is selected as the Master, and the other as Slave, OR configure the jumpers on the HD for CS (Cable Select), and the DVR 116 will do this automatically.

The jumper settings for Master / Slave / Cable Select are usually labeled on the top side of the HDD and the location of the jumpers can usually be found beside the cable connector on the HDD

Step 6: Secure the HDD in the cartridge casing.

Position the HDD into place and secure it using the six screws supplied.

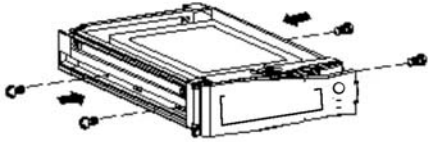

Step 7: Slide the top Cover over the Cartridge Casing

Slide the Cover forward over the Cartridge Case. Ensure it is secured in place over the release latch.

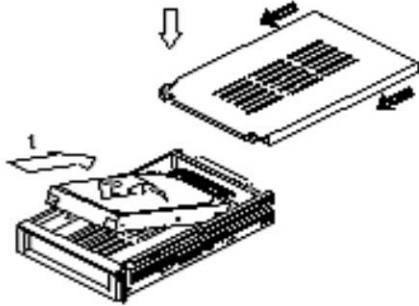

Reinsert the Cartridge Casing into the DGR116

Step 8: Lock the Cartridge

To Lock the cabinet, turn the key clockwise to Position A.

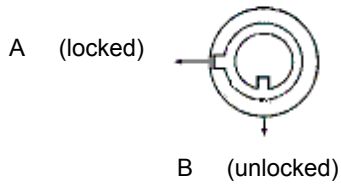

To unlock the cabinet, turn the key counter-clockwise to Position B.

NOTE: The DGR116 will not feature if the key is not in the locked position.

Appendix 2: Connection Diagram to Cameras and Monitor

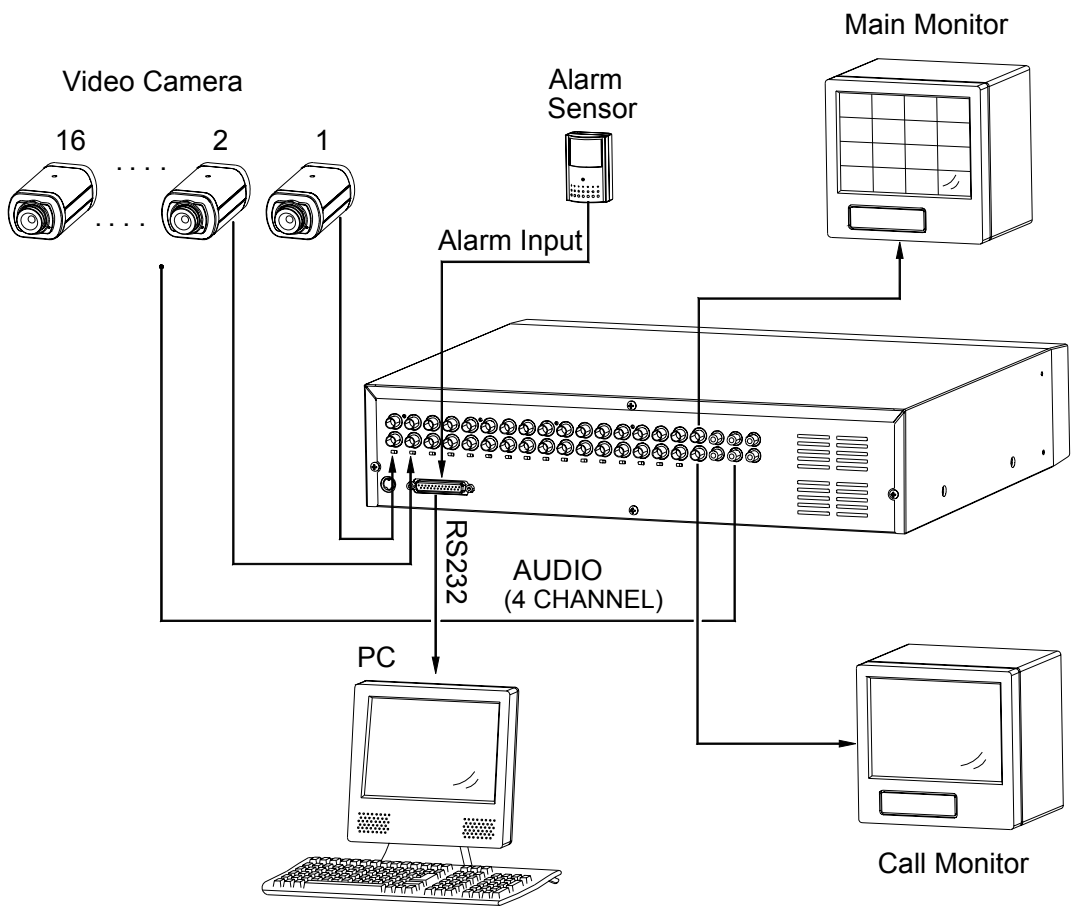

Appendix 3: Pin Configurations

External I/O

25 pin com port

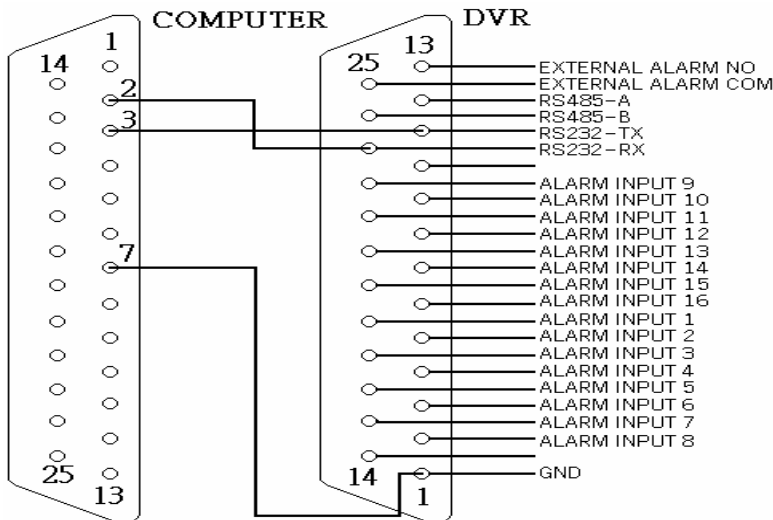

9 pin com port

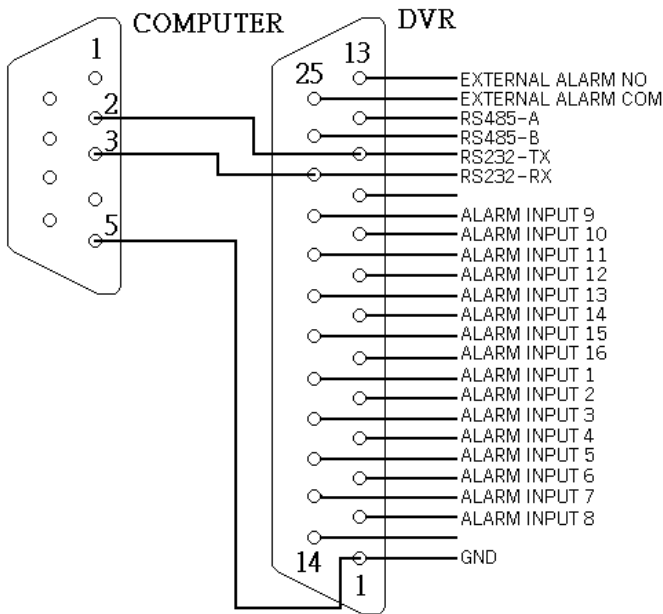

Pin References for RS-232 / Alarm Block

PIN 1. GND

GROUND

PIN 2. ALARM INPUT 8

Used to connect an alarm sensor between **ALARM INPUT 8 (PIN 2)** and **GND (PIN 1)** to trigger an alarm on Camera 8 which can activate the internal audible alarm and start recording.

PIN 3. ALARM INPUT 6

Used to connect an alarm sensor between **ALARM INPUT 6 (PIN 3)** and **GND (PIN 1)** to trigger an alarm on Camera 6 which can activate the internal audible alarm and start recording.

PIN 4. ALARM INPUT 4

Used to connect an alarm sensor between **ALARM INPUT 4 (PIN 4)** and **GND (PIN 1)** to trigger an alarm on Camera 4 which can activate the internal audible alarm and start recording.

PIN 5. ALARM INPUT 2

Used to connect an alarm sensor between **ALARM INPUT 2 (PIN 5)** and **GND (PIN 1)** to trigger an alarm on Camera 5 which can activate the internal audible alarm and start recording.

PIN 6. ALARM INPUT 16

Used to connect an alarm sensor between **ALARM INPUT 16 (PIN 6)** and **GND (PIN 1)** to trigger an alarm on Camera 16 which can activate the internal audible alarm and start recording.

PIN 7. ALARM INPUT 14

Used to connect an alarm sensor between **ALARM INPUT 14 (PIN 7)** and **GND (PIN 1)** to trigger an alarm on Camera 14 which can activate the internal audible alarm and start recording.

PIN 8. ALARM INPUT 12

Used to connect an alarm sensor between **ALARM INPUT 12 (PIN 8)** and **GND (PIN 1)** to trigger an alarm on Camera 12 which can activate the internal audible alarm and start recording.

PIN 9. ALARM INPUT 10

Used to connect an alarm sensor between **ALARM INPUT 10 (PIN 9)** and **GND (PIN 1)** to trigger an alarm on Camera 10 which can activate the internal audible alarm and start recording.

PIN 10. PIN OFF

PIN 11. RS232-TX

The DVR can be controlled remotely by an external device or control system, such as a control keyboard, using RS-232 serial communications signals.

PIN 12. RS485-A

The DVR can be controlled remotely by an external device or control system, such as a control keyboard, using RS485 serial communications signals.

PIN 13. EXTERNAL ALARM NO

Under normal operation COM disconnect with NO. But when Alarm triggered, COM connect with NO.

PIN 14. PIN OFF

PIN 15. ALARM INPUT 7

Used to connect an alarm sensor between **ALARM INPUT 7 (PIN 15)** and **GND (PIN 1)** to trigger an alarm on Camera 7 which can activate the internal audible alarm and start recording.

PIN 16. ALARM INPUT 5

Used to connect an alarm sensor between **ALARM INPUT 5 (PIN 16)** and **GND (PIN 1)** to trigger an alarm on Camera 5 which can activate the internal audible alarm and start recording.

PIN 17. ALARM INPUT 3

Used to connect an alarm sensor between **ALARM INPUT 3 (PIN 17)** and **GND (PIN 1)** to trigger an alarm on Camera 3 which can activate the internal audible alarm and start recording.

PIN 18. ALARM INPUT 1

Used to connect an alarm sensor between **ALARM INPUT 1 (PIN 18)** and **GND (PIN 1)** to trigger an alarm on Camera 1 which can activate the internal audible alarm and start recording.

PIN 19. ALARM INPUT 15

Used to connect an alarm sensor between **ALARM INPUT 15 (PIN 19) and GND (PIN 1)** to trigger an alarm on Camera 15 which can activate the internal audible alarm and start recording.

PIN 20. ALARM INPUT 13

Used to connect an alarm sensor between **ALARM INPUT 13 (PIN 20) and GND (PIN 1)** to trigger an alarm on Camera 13 which can activate the internal audible alarm and start recording.

PIN 21. ALARM INPUT 11

Used to connect an alarm sensor between **ALARM INPUT 11 (PIN 21) and GND (PIN 1)** to trigger an alarm on Camera 11 which can activate the internal audible alarm and start recording.

PIN 22. ALARM INPUT 9

Used to connect an alarm sensor between **ALARM INPUT 9 (PIN 22) and GND (PIN 1)** to trigger an alarm on Camera 9 which can activate the internal audible alarm and start recording.

PIN 23. RS232-RX

The DVR can be controlled remotely by an external device or control system, such as a control keyboard, using RS-232 serial communications signals.

PIN 24. RS485-B

The DVR can be controlled remotely by an external device or control system, such as a control keyboard, using RS485 serial communications signals.

PIN 25. EXTERNAL ALARM COM

Under normal operation COM disconnect with NO. But when alarm triggered, COM connect with NO.

Appendix 4: Rack Mount Installation

Screws and brackets for rack mounting applications can be purchased as an optional accessory.

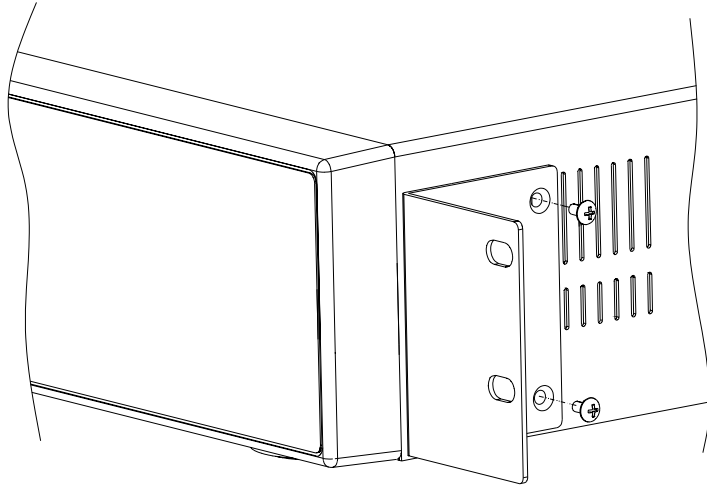

Front Angle with Rack Mount

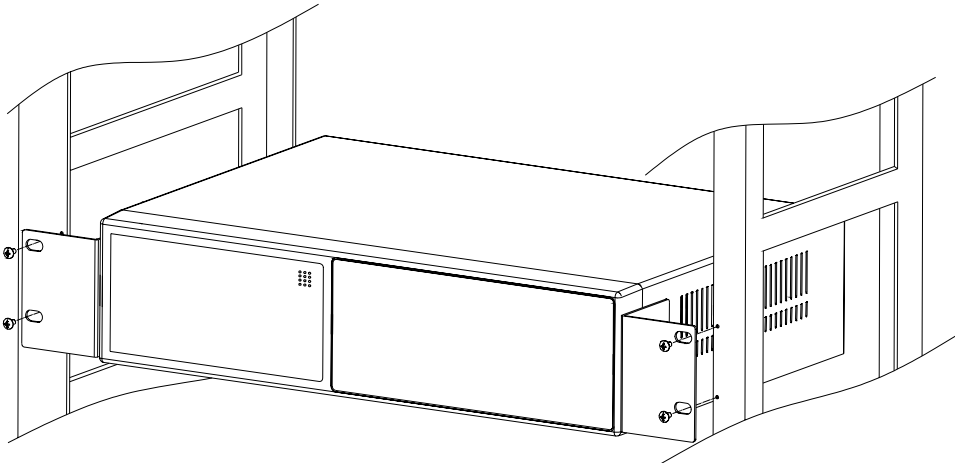

Side View with Rack Mount

For more information about the rack mount & other accessories through Digimerge, please visit: www.digimerge.com.

Appendix 5: Recording Times (in Hours)

NTSC SYSTEM

IPS		15A	15	8	4	2	1
Record Quality	Best	24hr	48hr	90hr	180hr	360hr	720hr
	High	30hr	60hr	113hr	225hr	450hr	900hr
	Normal	48hr	96hr	160hr	360hr	720hr	2560hr
	Basic	80hr	160hr	300hr	600hr	1200hr	3200hr
HDD Type		120GB					

IPS		15A	15	8	4	2	1
Record Quality	Best	32hr	64hr	120hr	240hr	480hr	960hr
	High	40hr	80hr	160hr	300hr	600hr	1200hr
	Normal	64hr	128hr	212hr	480hr	960hr	2880hr
	Basic	106hr	212hr	430hr	800hr	1600hr	4800hr
HDD Type		160GB					

IPS		15A	15	8	4	2	1
Record Quality	Best	48hr	96hr	180hr	360hr	720hr	1440hr
	High	60hr	120hr	226hr	450hr	900hr	1800hr
	Normal	96hr	192hr	360hr	720hr	1440hr	2880hr
	Basic	160hr	320hr	600hr	1200hr	2400hr	4800hr
HDD Type		240GB					

Appendix 6: RS232 Remote Protocol

The RS-232 protocol allows you to control the DGR116 from a PC or any other serial device.
Data: 8 bit data, 1 start bit, 1 stop bit

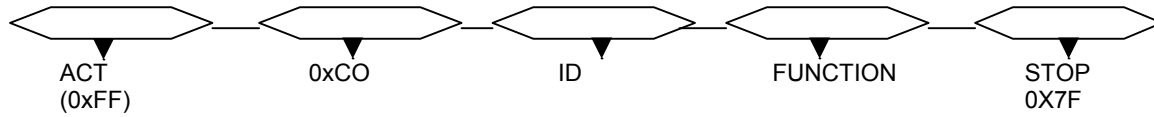

FEATURE	CODE	ASCII		FEATURE	CODE	ASCII
MENU Key	0x4D	M		CH1 Key	0x31	1
SELECT Key	0x73	s		CH2 Key	0x32	2
ENTER Key	0x0D	ENTER		CH3 Key	0x33	3
4CUT Key	0x61	a		CH4 Key	0x34	4
ZOOM Key	0x5A	Z		CH5 Key	0x35	5
9CUT Key	0x62	b		CH6 Key	0x36	6
PIP Key	0x70	p		CH7 Key	0x37	7
16CUT Key	0x63	c		CH8 Key	0x38	8
SLOW Key	0x53	S		CH9 Key	0x39	9
REC Key	0x72	r		CH10 Key	0x41	A
LEFT Key	0x4C	L		CH11 Key	0x42	B
UP Key	0x55	U		CH12 Key	0x43	C
PLAY Key	0x50	P		CH13 Key	0x44	D
DOWN Key	0x4E	N		CH14 Key	0x45	E
RIGHT Key	0x52	R		CH15 Key	0x46	F
POWER Key	0x57	W		CH16 Key	0x47	G
LOCK Key	0x4B	K				

Appendix 7: Compatible HDD Brands

Manufacturer	Model	Capacity	Rotation
IBM	Deskstar 120GXP (40GB)	40GB	7200 rpm
IBM	Deskstar 60GXP IC35I060	60GB	7200 rpm
IBM	Deskstar 120GXP (80GB)	80GB	7200 rpm
IBM	Deskstar 120GXP (120GB)	120GB	7200 rpm
Maxtor	DiamondMax 536DX(60GB) 4W060H4	60GB	5400 rpm
Maxtor	DiamondMax Plus 9, Model#6Y120L	120GB	7200 rpm
Seagate	Barracuda ATA IV ST340016A	40GB	7200 rpm
Seagate	Barracuda ATA V, ST3120023A	120GB	7200 rpm
Western Digital	Caviar WD400BB-00BSA0	40GB	7200 rpm
Western Digital	Caviar WD400EB-00CPF0	40GB	5400 rpm

Note: The above brands and models of HDD have been tested and they are compatible with the DGR116.

Limited Warranty

Warranty: Subject to the exclusions and limitations below, Digimerge warrants to the initial end-user purchaser that the product will be free from defects in material and workmanship for a period of one year from the date of purchase. For valid warranty claims made during the warranty period, upon proof of purchase, defective products will, at the election of Digimerge, be repaired or replaced without charge. Any products repaired or replaced within the warranty period, shall be warranted by Digimerge to the initial end-user purchaser for 90 days from the return shipment date, or the remainder of the warranty term, whichever is longer, and if outside of the warranty period then for 90 days from the return shipment date. Products and parts may be replaced with refurbished items, and the products and parts replaced become the property of Digimerge. You are responsible for all shipping costs associated with the return of the defective products for warranty service.

Exclusions and Limitations: Any of the following will void this warranty:

- (i) installation or use of the product other than strictly in accordance with the instructions contained in the product's instruction manual;
- (ii) if the product is subjected to operating conditions (including atmospheric, moisture and humidity conditions) outside of the acceptable conditions specified in the product's instruction manual;
- (iii) if the product is subjected to misuse or abuse;
- (iv) if the product is subjected to electrical short circuits or transients, accident, fire, flood or Acts of God;
- (v) adjustment, maintenance or repair of the product other than in accordance with Digimerge approved procedures; and
- (vi) use of replacement parts other than those specified by Digimerge.

DIGIMERGE MAKES NO CLAIMS OR WARRANTIES OF ANY KIND WHATSOEVER REGARDING THE PRODUCT'S ABILITY OR EFFECTIVENESS IN PREVENTING OR REDUCING THE RISK OF, OR DAMAGES RESULTING FROM, LOSS OR THEFT OF PROPERTY OR PERSONAL INJURY.

THIS LIMITED WARRANTY IS IN LIEU OF ALL OTHER WARRANTIES, EXPRESS OR IMPLIED, INCLUDING, BUT NOT LIMITED TO, ANY IMPLIED WARRANTY OF MERCHANTABILITY OR FITNESS FOR A PARTICULAR USE OR PURPOSE.

REPAIR OR REPLACEMENT AS PROVIDED UNDER THIS LIMITED WARRANTY IS THE EXCLUSIVE REMEDY OF THE PURCHASER. DIGIMERGE SHALL IN NO EVENT BE LIABLE FOR ANY SPECIAL, INDIRECT, INCIDENTAL, PUNITIVE, OR CONSEQUENTIAL DAMAGES OF ANY KIND OR CHARACTER, INCLUDING, WITHOUT LIMITATION, PERSONAL INJURY, LOSS OF REVENUE OR PROFITS, FAILURE TO REALIZE SAVINGS OR OTHER BENEFITS, OR CLAIMS AGAINST THE PURCHASER BY ANY THIRD PERSON, EVEN IF DIGIMERGE HAS BEEN ADVISED OF THE POSSIBILITY OF SUCH DAMAGES.

No claims or statements regarding the product, whether written or verbal, by salespeople, retailers, dealers or distributors, that are not contained in this limited warranty or in the owner's manual are authorized by Digimerge and do not modify or expand this warranty.

Some countries, states, or provinces do not allow the exclusion or limitation of implied warranties or the limitation of incidental or consequential damages for certain products supplied to consumers or the limitation of liability for personal injury. To the extent that such restrictions on limitations apply to the products, the above limitations and exclusions may be limited in their application. In that case, when the implied warranties are not allowed to be excluded in their entirety, they will be limited to the duration of the applicable written warranty, and if damages may not be limited then the above limitations on damages apply, but only to the greatest extent permitted by local law.

Warranty and Non-Warranty Service: Contact the dealer that sold you this product, during the warranty period if applicable, to obtain service. Non-warranty service is subject to Digimerge's then current service terms and prices. If the dealer fails to respond, cannot be reached or fails to provide you with the required service, you may obtain service directly from Digimerge by calling our service department at (866) 344-4674. You must provide Digimerge with the defective product's model number, serial number, date of purchase, sales or invoice number, proof that you were the original end-user purchaser for warranty work, and a brief description of the problem. You must obtain a return authorization number from the service department and must mark the number clearly on the shipping box. You must ship the item prepaid in appropriate packaging to the following address:

Digimerge Technologies Inc.,
Attention: Repair Department,
300 Alden Rd,
Markham, Ontario, Canada,
L3R 4C1

Digimerge Technologies Inc.

300 Alden Road
Markham Ontario
L3R 4C1

www.digimerge.com

rev06
